

Montage, Rollen, Stuhlsäule und Rückenlehne

Assembly, castors, chair column and backrest

Montage, roulettes, vérin et dossier

Montage, wielen, gasveer en rugleuning

Montaje, ruedas, pistón de gas y respaldo

Montaggio, ruote colonna centrale, pistone a gas con schienale

1.

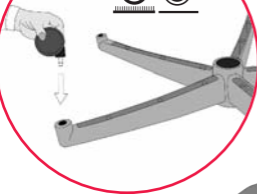

2.



3.

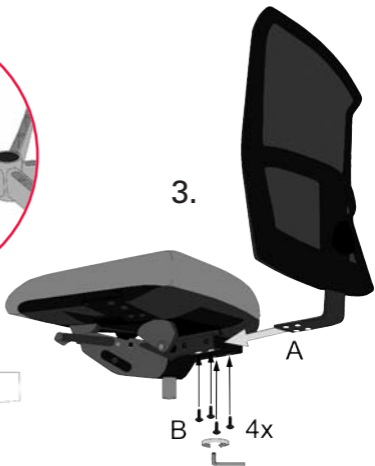

Montage, Armlehnen  
Assembly, armrests  
Montage, accoudoirs  
Montage, armleggers  
Montaje, brazos  
Montaggio, braccioli

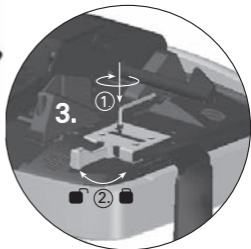
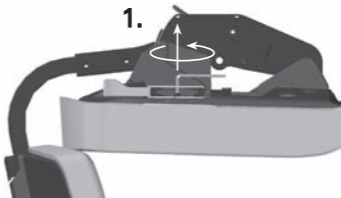



Sitzhöhenverstellung

Seat height adjustment

Réglage de la hauteur d'assise

Zithoogteverstelling

Regulación de altura del asiento

Regolazione altezza seduta





Synchronmechanik

Synchronous mechanism

Mécanisme synchrone

Synchroontechniek

Mecanismo sincronizado

Meccanismo syncro



180°





Gewichtsregulierung

Weight adjustment

Réglage de tension

Gewichtsregeling

Regulación de peso

Regolazione peso

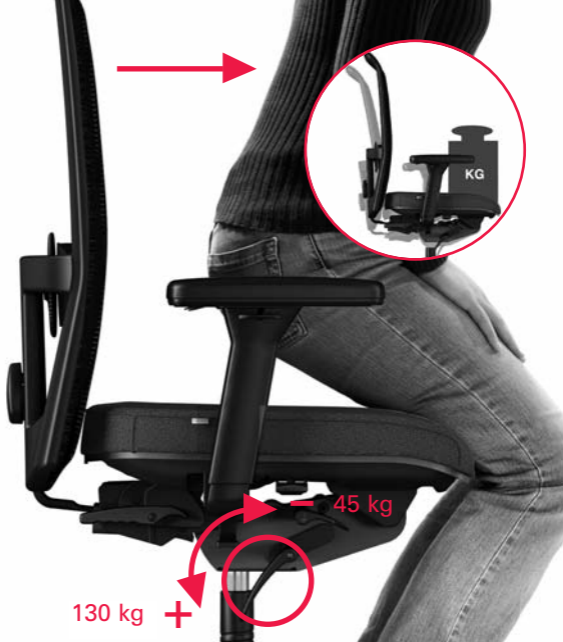

45 kg

130 kg +



Lordosenstütze (Option)

Lumbar support (option)

Soutien lombaire (option)

Lendensteun (optie)

Apoyo lumbar (opción)

Supporto lombare (opzione)

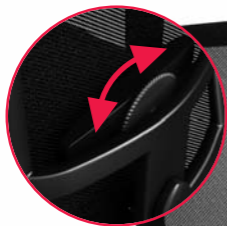



Rückenlehnen-Höhenverstellung

Back height adjustment

Dossier réglable en hauteur

Rugleuning in hoogte verstelbaar

Regulación de altura del respaldo

Regolazione altezza schienale





Sitztiefenverstellung (Option)

Seat depth adjustment (option)

Réglage de la profondeur d'assise (option)

Zitdiepteverstelling (optie)

Regulación de la profundidad del asiento (opción)

Regolazione profondità seduta (opzione)







Sitzneigeverstellung (Option)

Seat inclination adjustment (option)

Réglage de l'inclinaison d'assise (option)

Zitneigeverstelling (optie)

Regulación de la inclinación del asiento (opción)

Regolazione inclinazione seduta (opzione)





Höhenverstellung der Armlehnen

Height adjustable armrests

Accoudoirs réglables en hauteur

Hoogteverstelling van de armleggers

Regulación de la altura de los brazos

Regolazione altezza braccioli





Breitenverstellung der Armlehnen

Width adjustable armrests

Accoudoirs réglables en largeur

Breedteverstelling van de armleggers

Regulación del ancho de los brazos

Regolazione larghezza braccioli

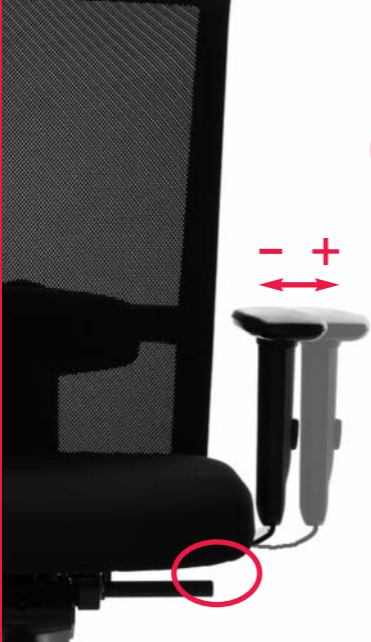



4D Armlehnen

4D armrests

4D accoudoirs

4D armleggers

4D brazos

4D braccioli

Tiefenverstellung der Armauflage

Adjustable arm supports

Manchettes réglables en profondeur

Armleggeropdek in diepte verstelbaar

Superficie de apoyo de los brazos regulable en profundidad

Regolazione parte superiore braccioli







4D Armlehnen

4D armrests

4D accoudoirs

4D armleggers

4D brazos

4D braccioli

Armauflage schwenkbar

Swivel arm support

Manchettes pivotantes

Armleggeropdek zwenkbaar

Brazos retrotraibles

Parte superiore del bracciolo girevole

